

# Inquiry form

## M2 ball disc styli and cylindrical styli



### Ball disc styli

Quantity:

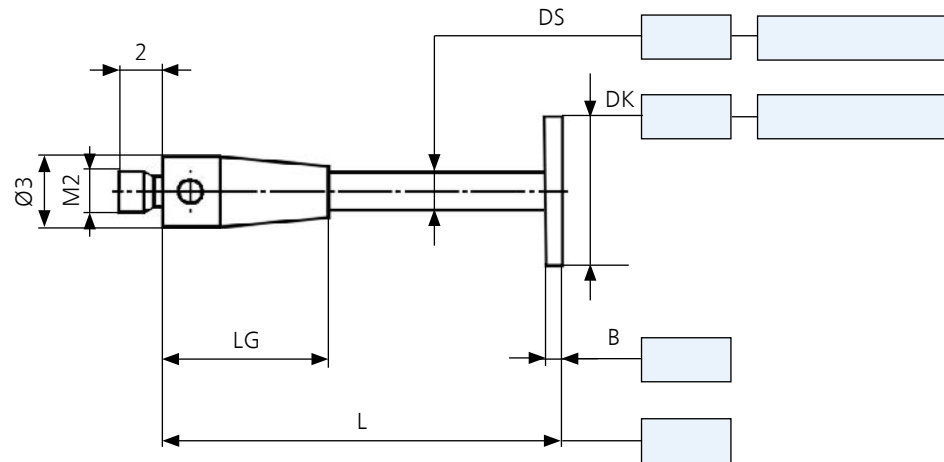

### Cylindrical styli

Quantity:

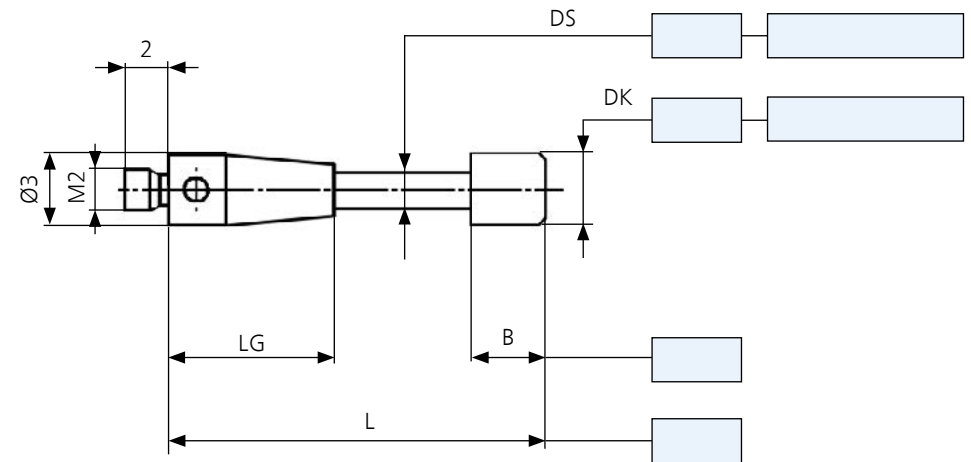

### Contact details:

Customer no.:

Company:

Department:

Zip code:

Name:

Email:

Street, no.:

City :

First name:

Phone:

Please fill in all blue fields. Enter your desired dimensions in mm and the angles in degrees.

Send by e-mail to:

**[accessories.metrology.de@zeiss.com](mailto:accessories.metrology.de@zeiss.com)**